

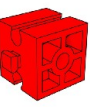

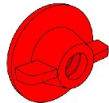









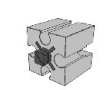
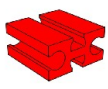
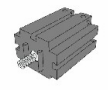

	<b>32985</b>
Grundplatte 258x186	1
	<b>31003</b>
Baustein 30 grau	10
	<b>31436</b>
Gelenkwürfel-Klaue	2
	<b>31426</b>
Gelenkwürfel-Zunge	2
	<b>32064</b>
Baustein 15 mit Bohrung	1
	<b>31982</b>
Federnocken	9

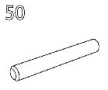
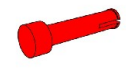
	<b>31058</b>
Nabenmutter mit Scheibe	2
	<b>31019</b>
Drehscheibe 60	1
	<b>35031</b>
Flachnabenzange	2
	<b>36264</b>
Zahnrad Z30	1
	<b>36297</b>
Winkelträger 60, gelb	4
	<b>31005</b>
Baustein 15, grau	4

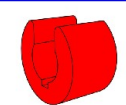
	<b>37468</b>
Baustein 7,5	2
	<b>32293</b>
Mini Motor 6-9V=; 0,65A max	1
	<b>31078</b>
U-Getriebe	1
	<b>31082</b>
Rastachse mit Zahnrad Z28,	1
	<b>35945</b>
Rast-Ritzel Z10, m=1,5	1
	<b>31033</b>
Metallachse 50	1

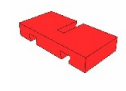
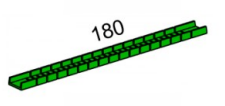
	<b>31690</b>
Rastachse 20	2
	<b>156105</b>
X-Strebe 42,4 silber	1
	<b>37679</b>
Klemmbuchse 5	2
	<b>31011</b>
Winkelstein 30 Grad	4
	<b>38428</b>
Bauplatte 15x30x5 mit 3 Nuten	4
	<b>143234</b>
Kugelbahn-Flexprofil 180 (grün)	4
	<b>144262</b>
Stahlkugel	1

# Baustufe 1

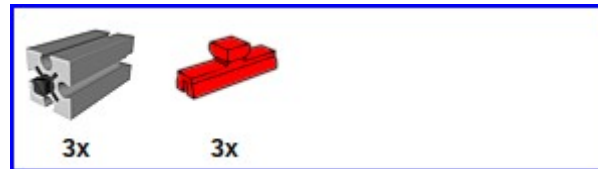
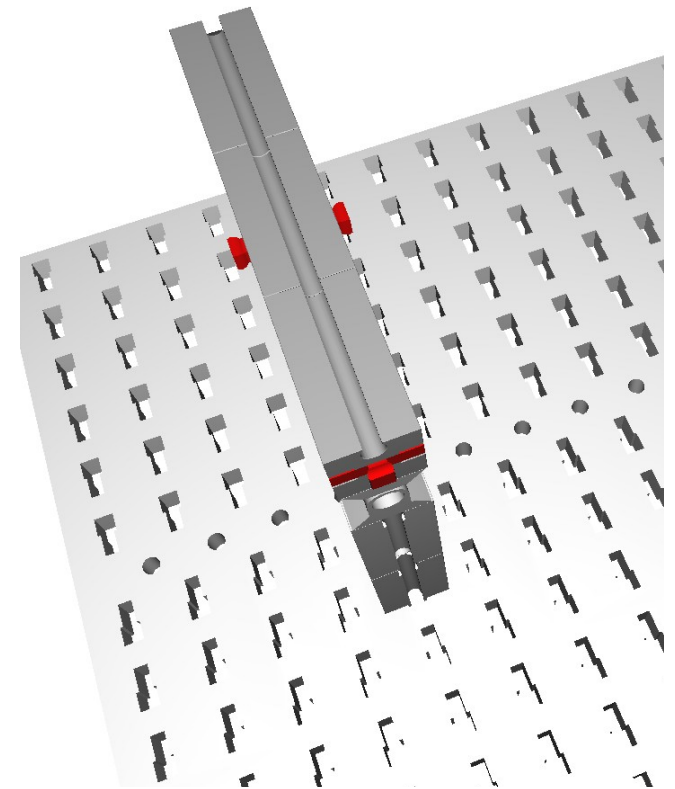
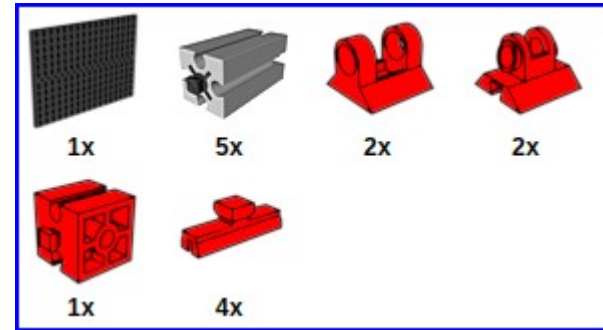
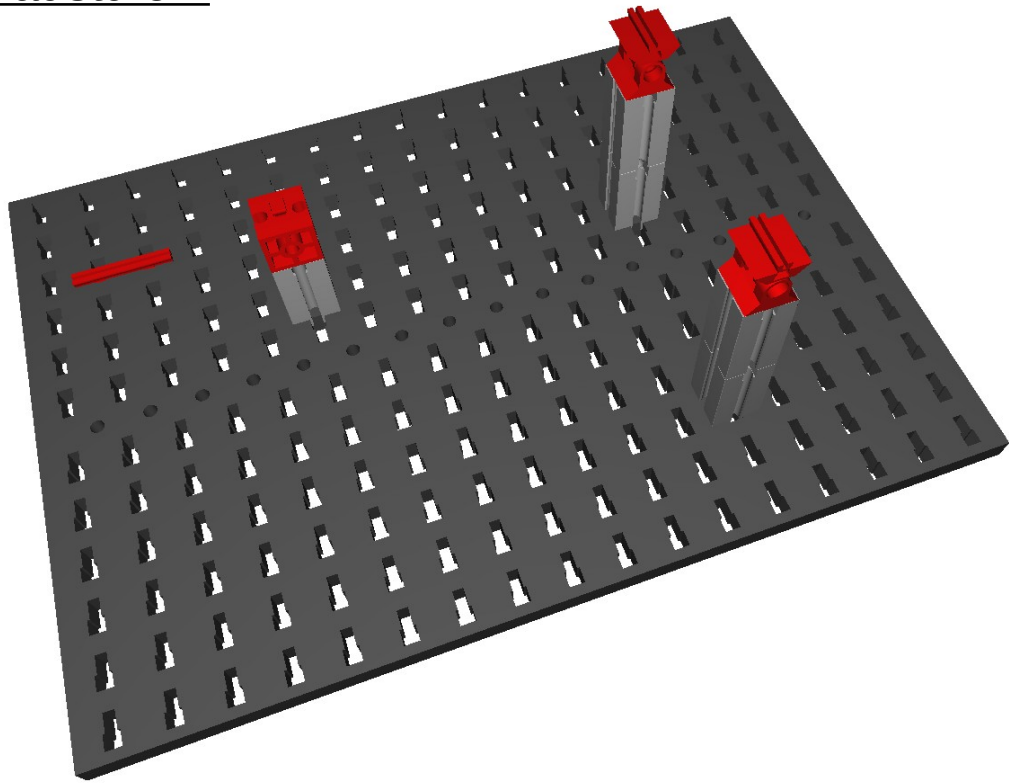



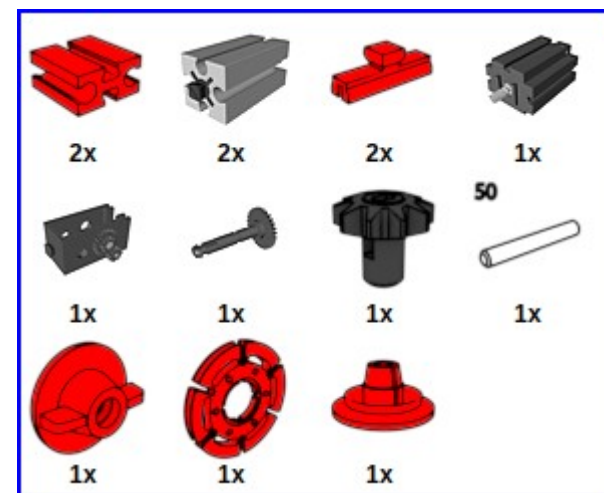
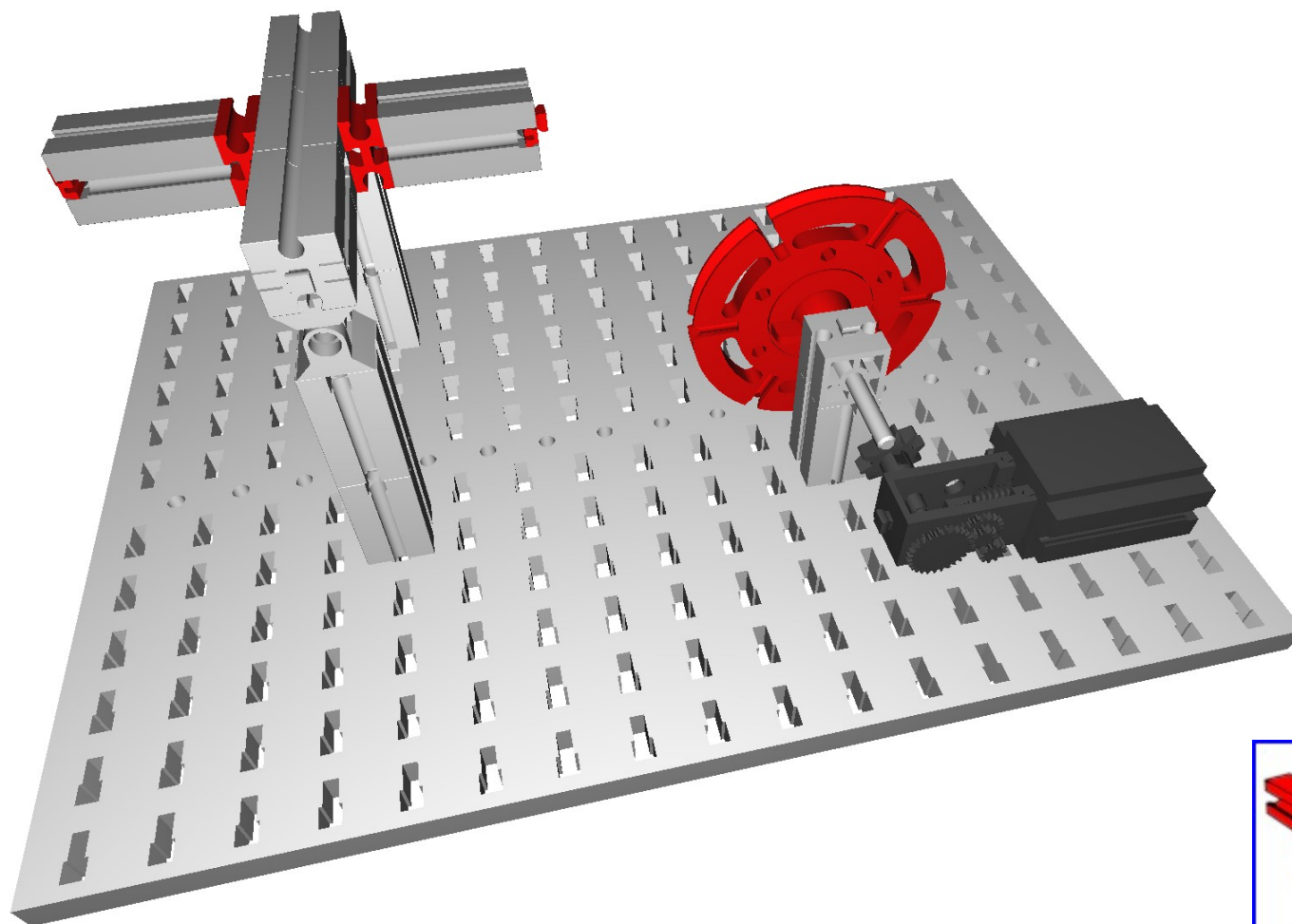



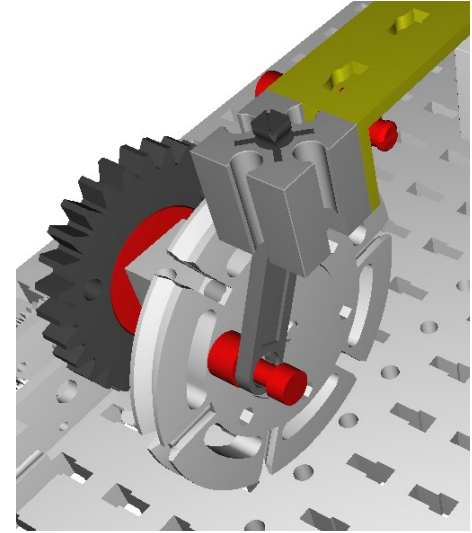
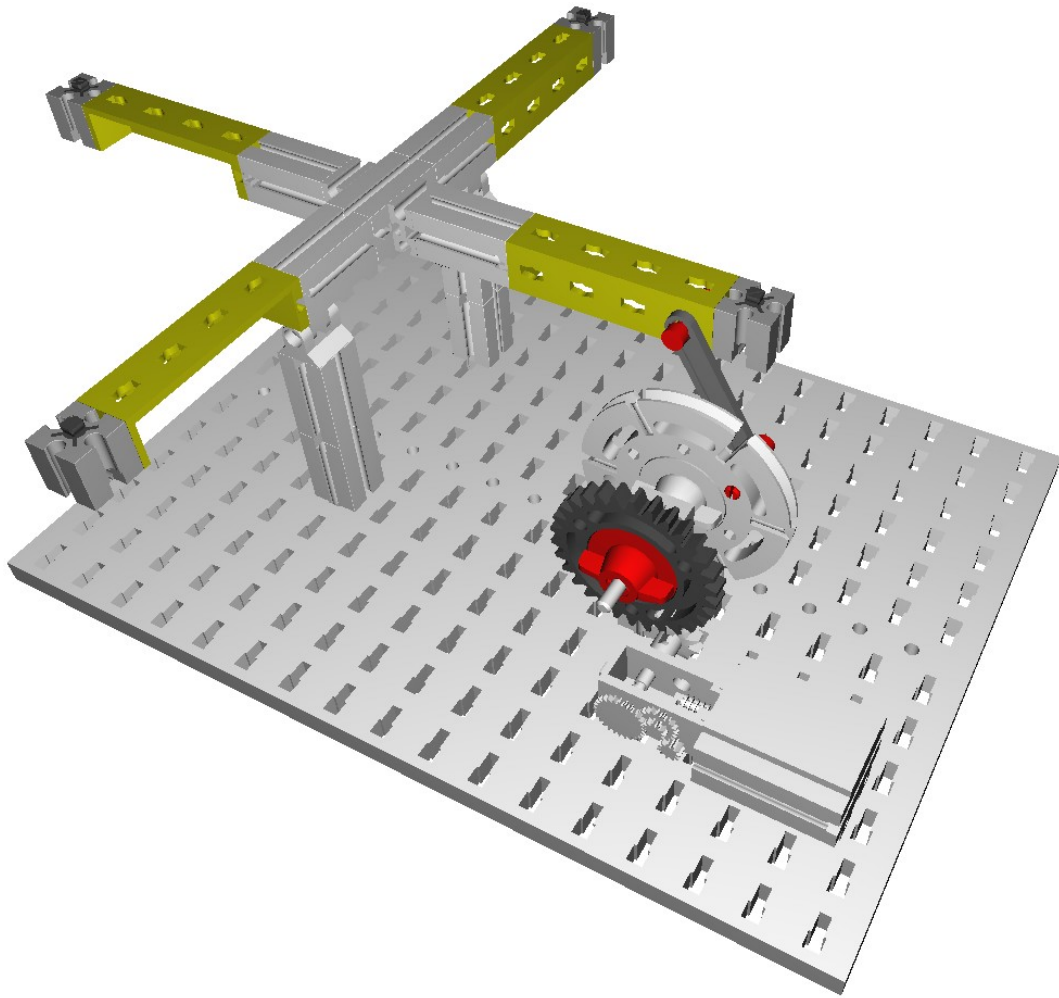

## Baustufe 2



# Baustufe 3



- |   |   |   |   |
|---|---|---|---|
|  |  |  |  |
| 1x  | 1x  | 1x  | 4x  |
|  |  |  |  |
| 4x  | 2x  | 1x  | 2x  |



# Baustufe 4

